

Ancho Cierres Código

Ángulo estándar 341-1400 1 RS 95VAN1144536
 Ángulo reducido 250-340 1 RS 95VAN1100986

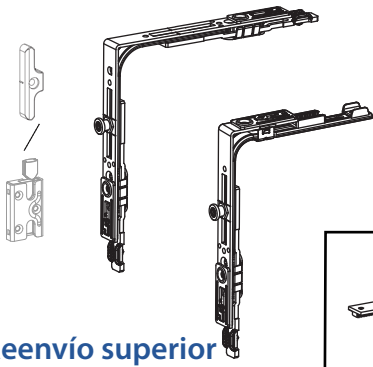

Reenvío superior

Ancho Mano Código

250-410 L 95VCO1123306
 R 95VCO1123307
 411-610 L 95VCO1083016
 R 95VCO1083017
 611-810 L 95VCO1083018
 R 95VCO1083019
 811-1400 L 95VCO1083020
 R 95VCO1083021

Compás

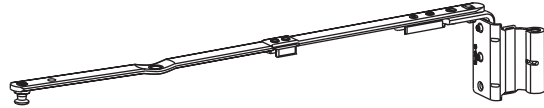

Pletina compás

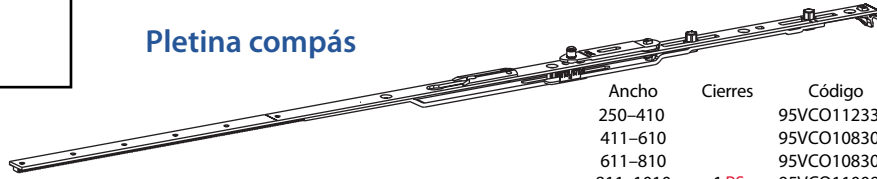

Ancho Cierres Código
 250-410 95VCO1123308
 411-610 95VCO1083038
 611-810 95VCO1083039
 811-1010 1 RS 95VCO1100978
 1011-1210 1 RS 95VCO1100980
 1211-1400 1 RS 95VCO1100981

Bisagra superior

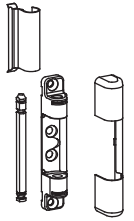

Biss. sup. 100 Kg
 95VBI1083250

S/color

Tapa Superior marco
 Tapa Superior compás

Falsa maniobra (opcional)

Hoja 95VCR1093907
 Marco 95VCR1105500

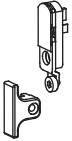

Cerraderos (elegir)



Cerradero 95VCE1105495

rodillo (seg.estándar)

cerradero seguridad



Cerradero seguridad

Derecha 95VCE1111122

Izquierda 95VCE1111123

Espaciador 95VCE1127521

Diagrama de aplicación

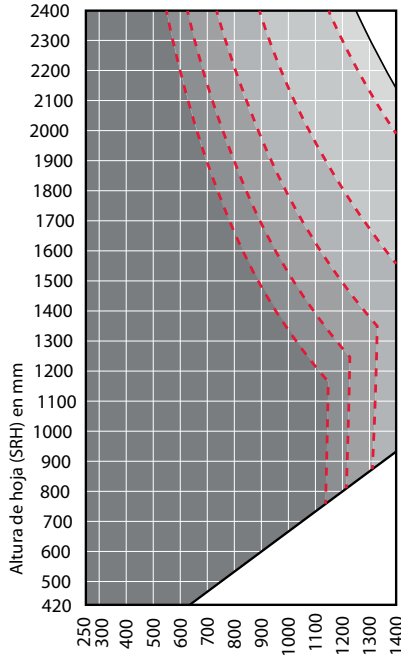

Peso vidrio [kg/m²]

- No aplicable
- 20 kg/m²
- 30 kg/m²
- 40 kg/m²
- 50 kg/m²
- 60 kg/m²
- 70 kg/m²

Cremona cota variable E15 seg.

Alto	Manilla	Cierres	Código
420-599 ¹⁾	380		95VCR1083117
600-1000	720	1 RS	95VCR1101035
1001-1400	1120	1 RS	95VCR1101036
1401-1800	1520	1 RS	95VCR1101037
1801-2000	1720	2 RS	95VCR1101038
2001-2400	2120	2 RS	95VCR1101039

1) falsa maniobra no aplicable



Línea
IRX

Tirante lateral

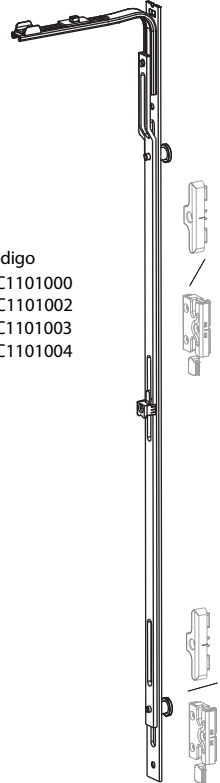

Alto	Cierres	Código
801-1200	2 RS	95VCC1101000
1201-1600	2 RS	95VCC1101002
1601-2200	3 RS	95VCC1101003
2201-2400	4 RS	95VCC1101004

Bisagra inf.-hoja 100 Kg a canal Derecha 95VBI1101245
 Bisagra inf.-hoja 100 Kg a canal Izquierda 95VBI1101244
 Bisagra inferior-marco 100 Kg 95VBI1083247

Bisagra inferior

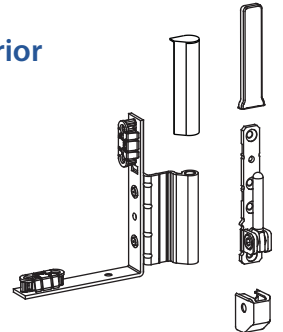

S/color

Tapa Inferior bisagra izda/dcha
 Tapa Inferior marco
 Tapa Inferior plano marco

Basculación inferior

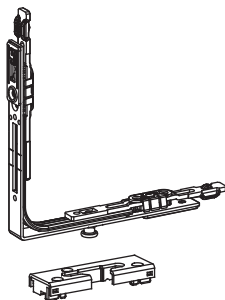

Ángulo de reenvío estándar 1 RS 95VAN1144536
 Cerradero de basculación Dcha 95VCE1110997
 Izda 95VCE1110998

Cierre horizontal

Ancho	Cierres	Código
801-1200	1 RS	95VCC1101006
1201-1400	1 RS	95VCC1101012

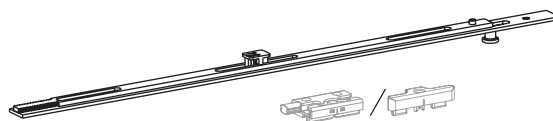

Esquema fabricación oscilobatiente 1 hoja cota variable
 bisagra vista 100 Kgs a canal regulable seguridad
 Sistema Canal 16 Aluminio

Bisagra superior

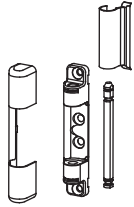

Biss. sup. 100 Kg
95VBI1083250

S/color

Tapa Superior marco
Tapa Superior compás

Falso compás

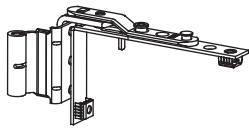

95VCO1083263 Izda.
95VCO1083262 Dcha.

Solución pasadores



Cerradero pasador
95VCE1105499



Ancho activa
341-1400
95VPA1083254



Ancho activa
250-340
95VPA1083253

Pasador superior

Solución falleba palanca

Seguridad básica Seguridad



Ángulo estándar
Ancho activa
341-1400
Cierres
1 RS
Código
95VAN1144536

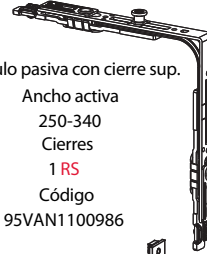

Ángulo pasiva con cierre sup.
Ancho activa
250-340
Cierres
1 RS
Código
95VAN1100986



Esquema fabricación hoja pasiva
cota variable bisagra vista 100 Kgs
regulable a canal seguridad
Sistema Canal 16 aluminio

Bisagra intermedia

Alto activa
800-1400 1 ud
1401-2000 2 uds
2001-2400 3 uds

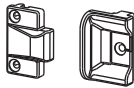

Hoja 95VBI1127509 Marco 95VBI1128331

Obligatoria con alto de activa entre 420-499 mm

Falsa maniobra (opcional)



95VCR1083293
Falsa maniobra
a canal inversora

Punto de cierre sobre inversora



Seg. estándar 95VCE1083207
Seguridad 95VCE1066042
600-1800 - 1ud
1801-2400 - 2uds

Falleba palanca c. variable

Alto activa	Código
500-599 ¹⁾	95VPA1098116
600-1000	95VPA1098120
1001-1400	95VPA1098122
1401-1800	95VPA1098123
1801-2000	95VPA1098124
2001-2400	95VPA1098125

1) falsa maniobra no aplicable

Falsa maniobra (opcional)



95VCR1083295
Falsa maniobra
a falleba palanca

Diagrama de aplicación (solución falleba palanca)

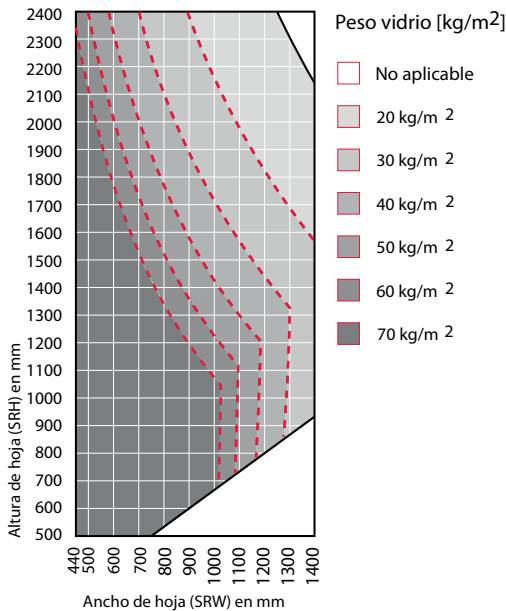

Bisagra inferior



Bisagra inf.-hoja 100 Kg a canal Derecha 95VBI1101245
Bisagra inf.-hoja 100 Kg a canal Izquierda 95VBI1101244
Bisagra inferior-marco 100 Kg 95VBI1083247

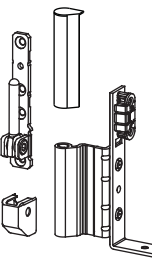

S/color

Tapa Inferior bisagra izquierda/derecha
Tapa Inferior marco
Tapa Inferior plano marco

Pasador inferior



Pasador inferior
95VPA1083252

Cerradero pasador
95VCE1105499

Ángulo estándar
Ancho activa
341-1400
Cierres
1 RS
Código
95VAN1144536

Seguridad básica Cerr. seguridad
Cerradero 95VCE1105495 Derecha 95VCE1111122
Izquierda 95VCE1111123
Espaciador 95VCE1127521

Activa